

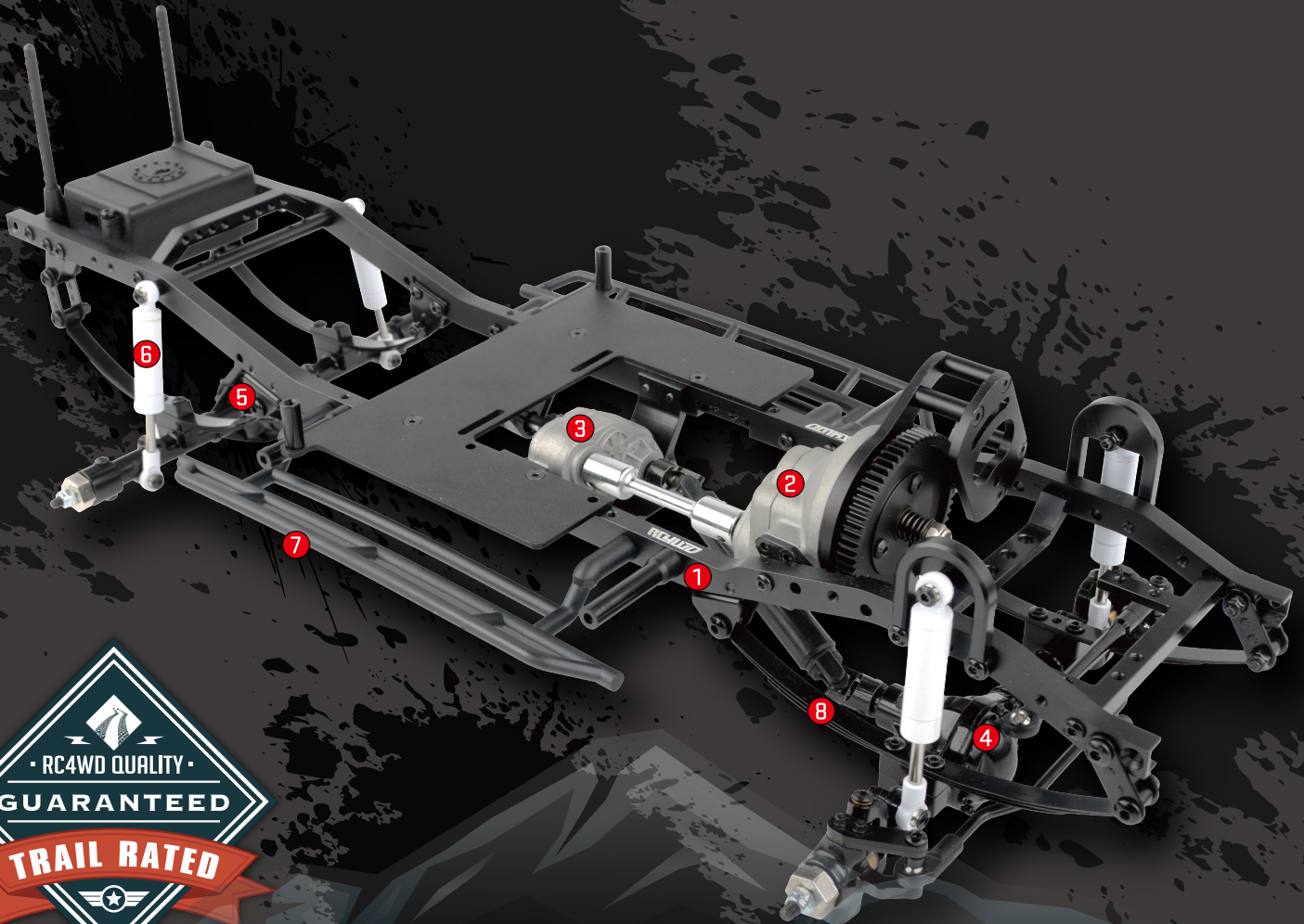

TRAIL FINDER 2 LWB

1/10 SCALE BUILDERS KIT



The Trail Finder 2 LWB has both style and aggressive performance. You will find a balance of scale details and performance built into every Trail Finder 2 LWB. Performance is smooth with its R3 Scale Single Speed transmission, 4WD drivetrain, Bulletproof Transfer Case, and quality metal components. The front axles have been upgraded with XVDs, providing sturdier construction and a greater steering angle than stock counterparts. The Trail Finder 2 LWB is a product of innovative engineering that impresses in appearance and performance.

The Trail Finder 2 LWB is fully compatible with an array of options and performance enhancements crafted to elevate the user experience and enhance the authenticity of a 1/10 off-road truck!

- 1 Realistic Billet Aluminum Ladder Frame Chassis
- 2 R3 Scale Single Speed Transmission
- 3 Center Mounted Realistic 4x4 Transfer Case
- 4 K44 Ultimate Scale Cast Front Axle with Upgraded XVD's
- 5 K44 Ultimate Scale Cast Rear Axle
- 6 Super Scale 70mm White Shocks W/ Internal Springs
- 7 RC4WD Marlin Crawler Side Plastic Sliders
- 8 Soft Steel Leaf Springs

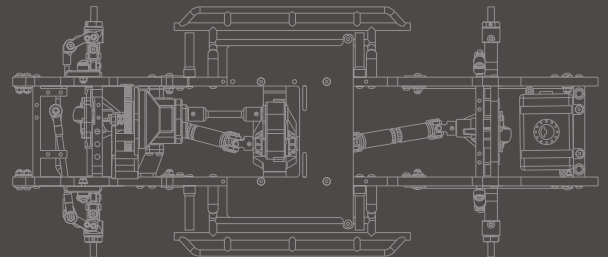



TRAIL FINDER 2 LWB

1/10 SCALE BUILDERS KIT

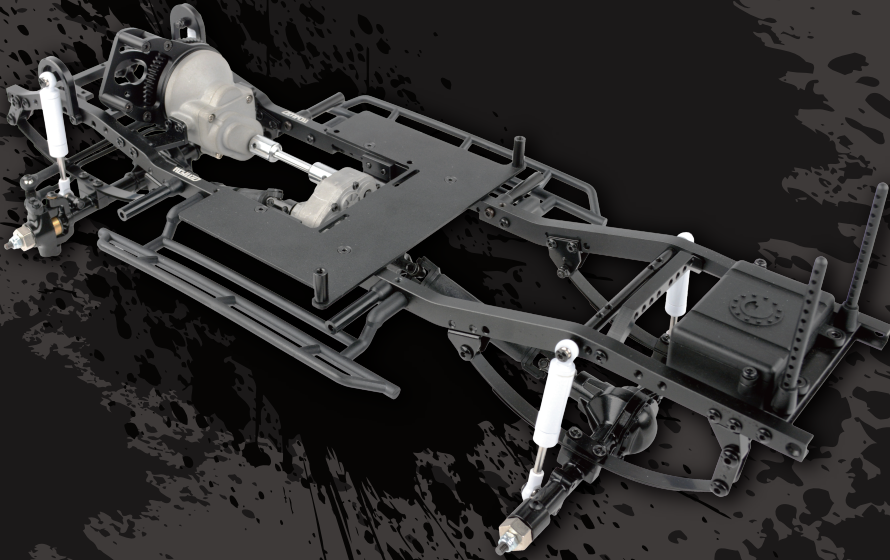

The R3 Single Speed Transmission comes with a tough cast metal case and wider gears to allow for more abuse along with a Delrin Spur with Slipper Clutch. It also features a sturdy billet aluminum motor mount for durability.



The Trail Finder 2 LWB Kit includes the Hammer Transfer Case. Packed with detail, the case features a cast metal exterior and the same 0.8 Mod widened gears for durability.



Drawing on the success of the RC4WD MOA gear sets, the TF2 LWB Kit Drivetrain has the most durable gears RC4WD has to offer so the TF2 LWB Kit can stay on the trail, day after day.



The most scale-accurate axles in the market, the RC4WD Yota II Ultimate Scale Cast Axles feature innovative round knuckles, lower mounting points, XVDs for the front axles and compact offset pumpkins.



The Drive Shafts for the TF2 LWB Kit are an all new design featuring bulletproof steel universals and a new high quality plastic shaft for great driveline angles and durability on the trail.

DRIVETRAIN

PRECISION ENGINEERED · BULLET-PROOF COMPONENTS · PERFORMANCE PARTS



TRAIL FINDER 2 LWB

1/10 SCALE BUILDERS KIT

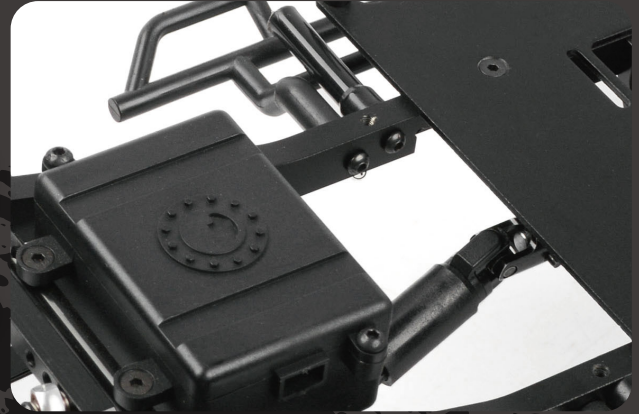
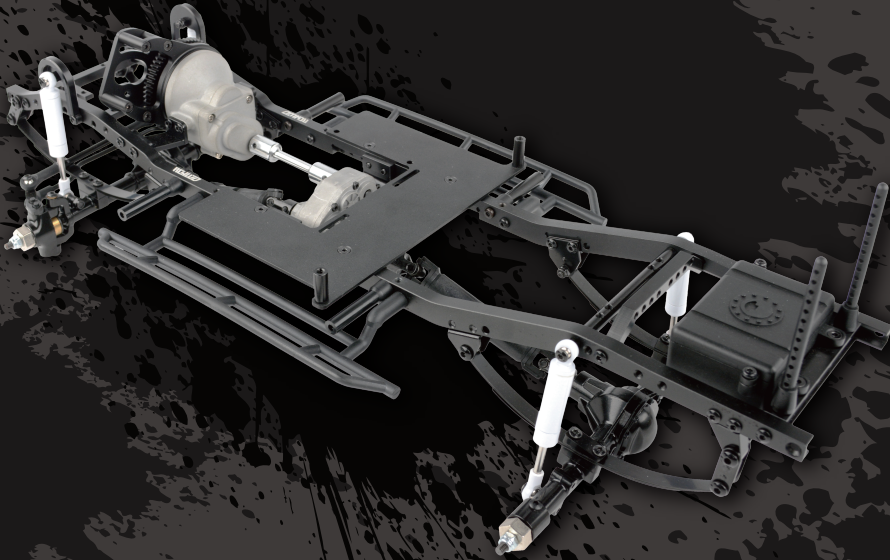

The TF2 LWB Kit Chassis features a molded fuel cell that doubles as an electronics storage box and an aluminum, frame mounted under cab electronics tray for multiple electronics tray for multiple mounting options for your electronics.



The TF2 LWB Kit includes a set of RC4WD Ultimate Scale Shocks. These shocks are designed for ultimate scale looks and optimum performance. They're machined from billet aluminum, are internally sprung and are completely rebuildable!

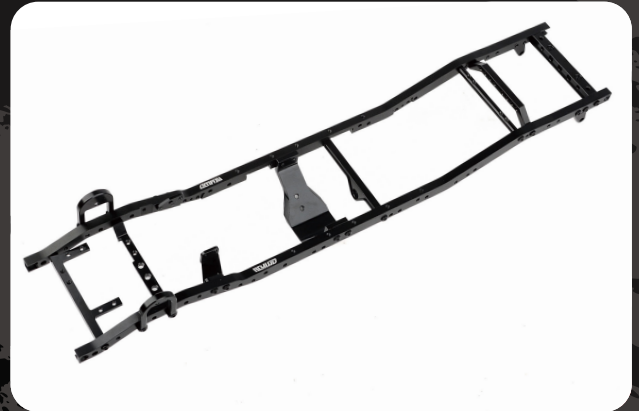

The TF2 LWB Kit Chassis is a machined billet aluminum ladder frame design with leaf springs, scale shock hoops, chassis servo mounts and hard body mounts and for maximum strength.



The TF2 LWB Kit includes a set of RC4WD White Stamped Steel 1.55" internal Beadlock Wheels. These wheels offer a super tough paintable white finish, aluminum internal ring and popular 6 Lug design.



Every TF2 LWB Kit needs a tough set of rock grabbing tires and the included Mud Thrashers in X3 Compound deliver the traction as well as perfect scale looks in just the right size.

SUPREMACY

PRECISION ENGINEERED · BULLET-PROOF COMPONENTS · PERFORMANCE PARTS

For more information, upgrades and all the latest news, visit us at: rc4wd.com



TRAIL FINDER 2 LWB

1/10 SCALE BUILDERS KIT

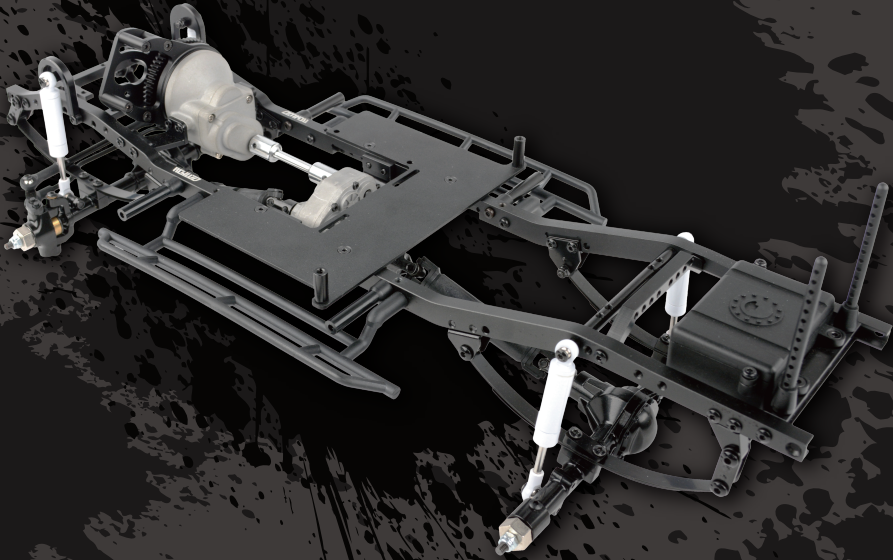

General Motors Trademarks used under license to RC4WD. The Z-B0258 RC4WD Chevrolet K10 Scottsdale Hard Body Complete Set is a perfect fit for the Trail Finder 2 LWB. Other bodies with a 314mm (12.36") wheel base can be adapted to this fit as well.

FOR DISPLAY ONLY, DOES NOT INCLUDE BODY.

SPECIFICATIONS

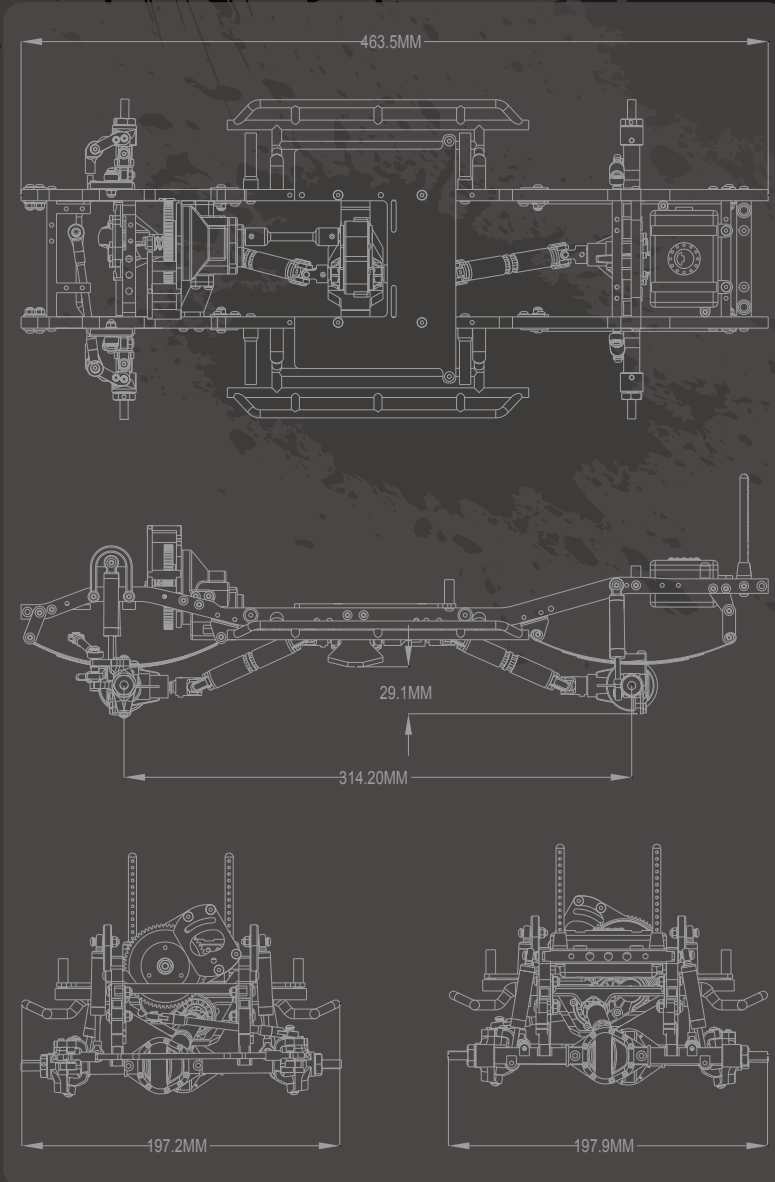

Hammer Transfer Case

Ratio: 1.47:1

Gears: Wide .8 Mod Steel Gears

Features: 8 Bearings, Cast Casing, Hardened Gears

R3 Scale Single Speed Transmission

Ratios: Pinion/Spur 14/64 = 1:4.57

Internal Ratio: 1.78:1

Gears: Wide Steel .8 Mod, Delrin Spur, Slipper Clutch

K44 Ultimate Scale Cast Axles

Ratio: 2.67:1

Hex To Hex Width: 177mm (6.96")

Trail Finder 2 "LWB" Chassis

Features: Billet Aluminum Construction, Adjustable Shock Hoops

Drive Shafts

High Quality Plastic Material, Very Durable High Quality Steel Yokes

TF2 "LWB" Truck Dimensions

Wheelbase: 314mm(12.4")

Width: 193mm(7.6")

Height: 118mm (4.65")

Ground clearance: 61.6mm(2.4")

Final Drive Ratios: 31.9:1

PRECISION ENGINEERED · BULLET-PROOF COMPONENTS · PERFORMANCE PARTS