

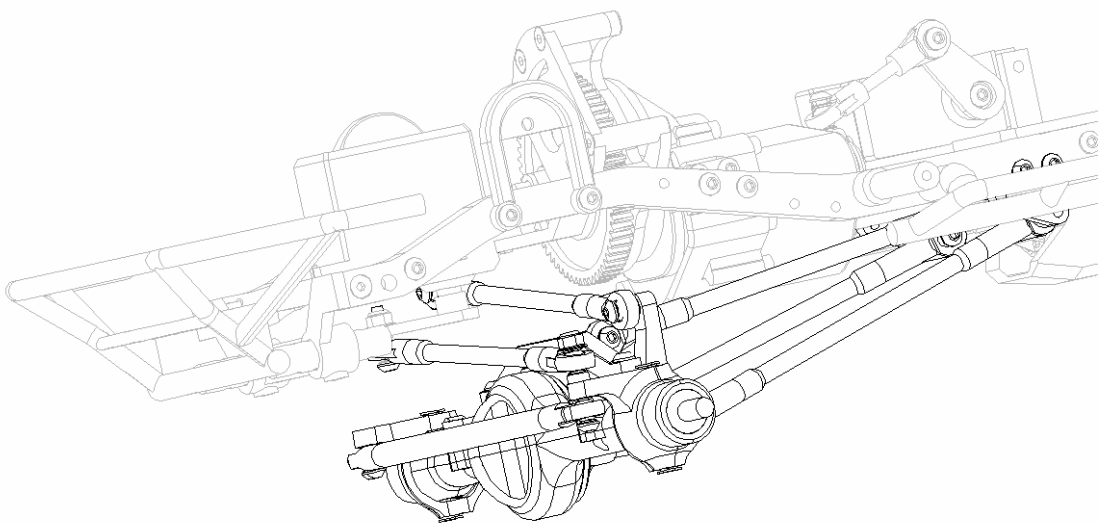

TRAILFINDER 2

FRONT 3 LINK + PANHARD BAR KIT



1

Remove front axle and leaf spring mounting hardware

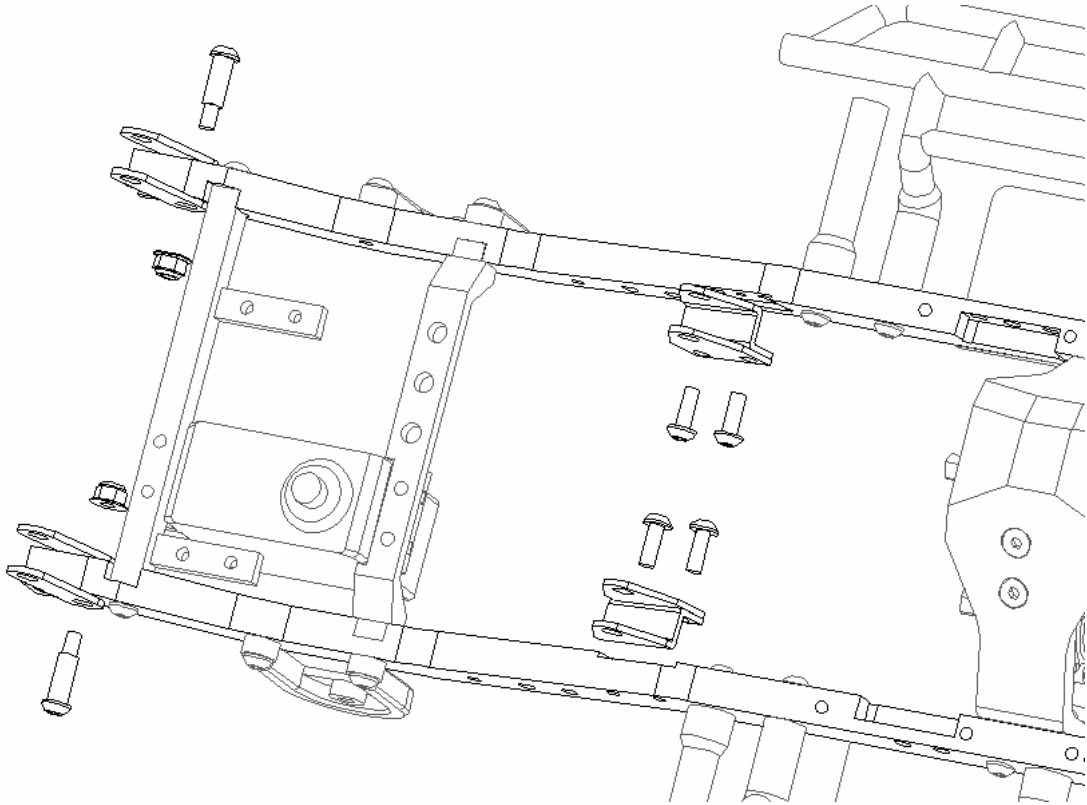

2

M3 x 12mm

M3 x 8mm Countersunk

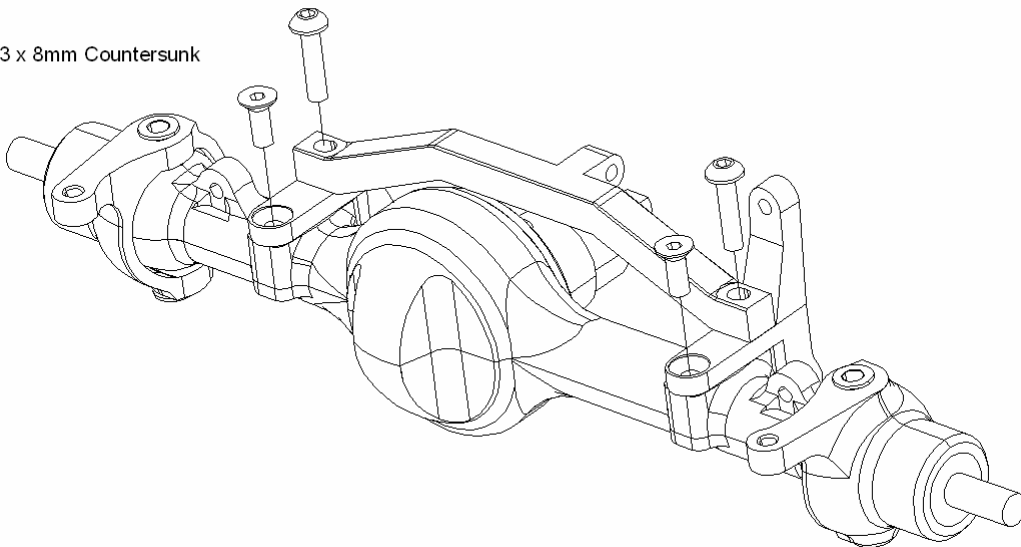

3

81mm link

Make 2

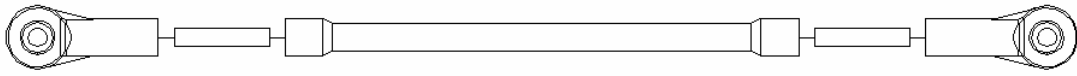

67mm link



60mm link

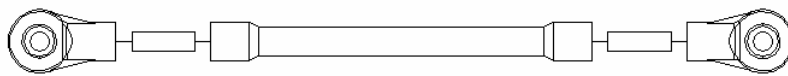

4

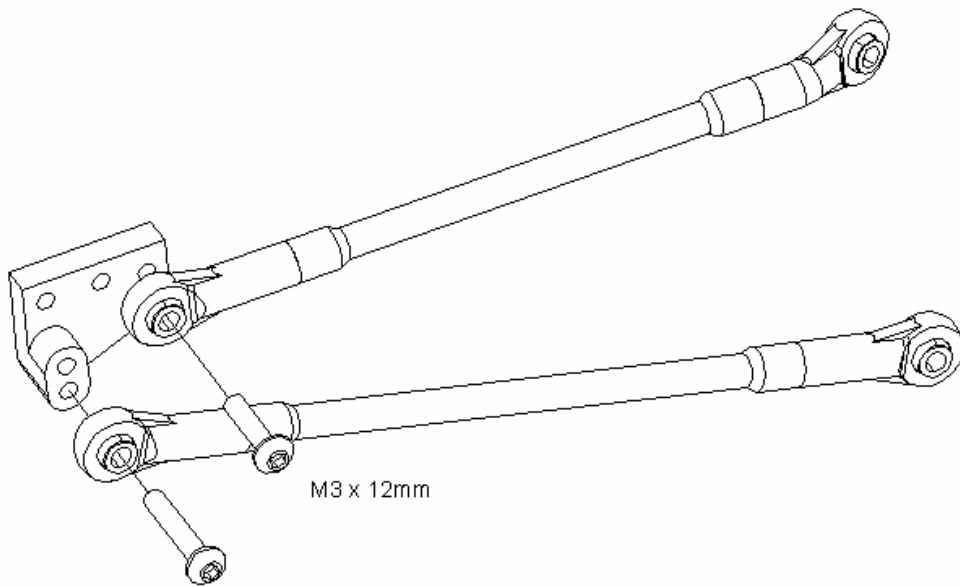

M3 x 16mm

M3 x 12mm

5

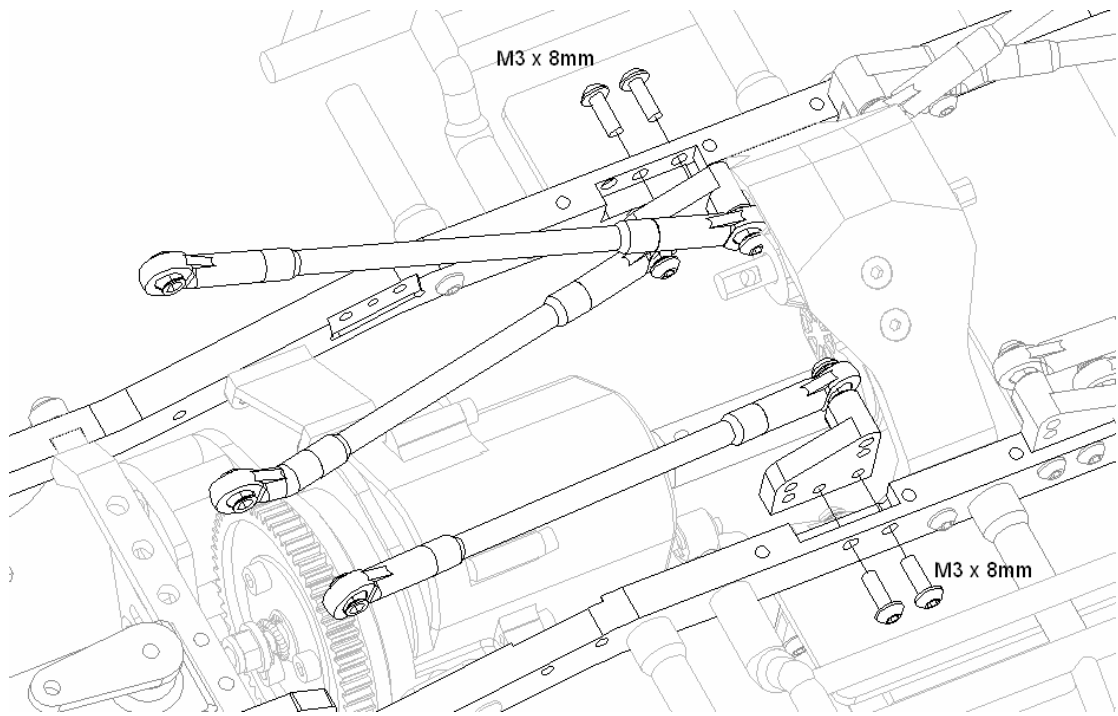

6

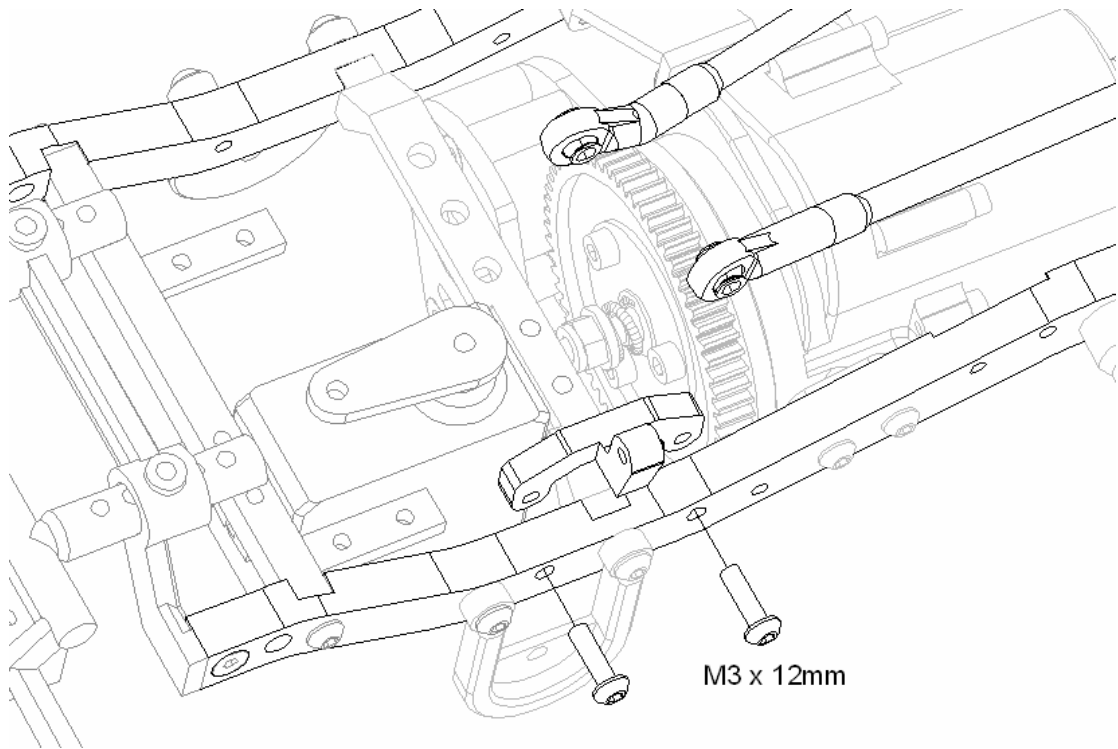

7

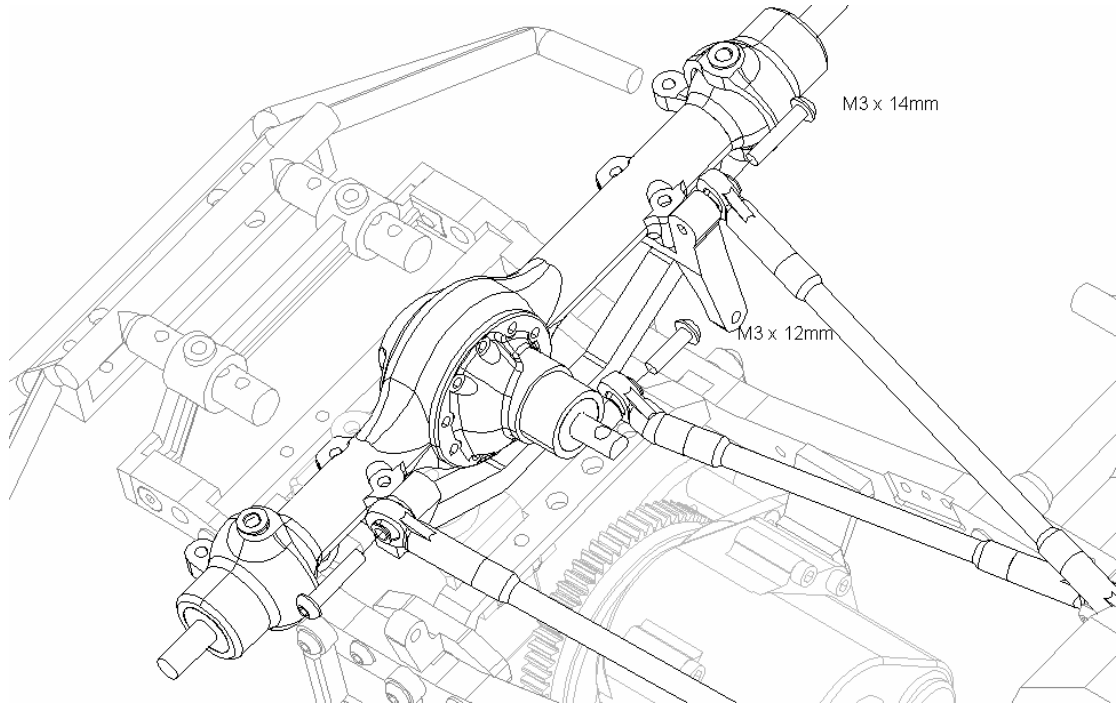

8

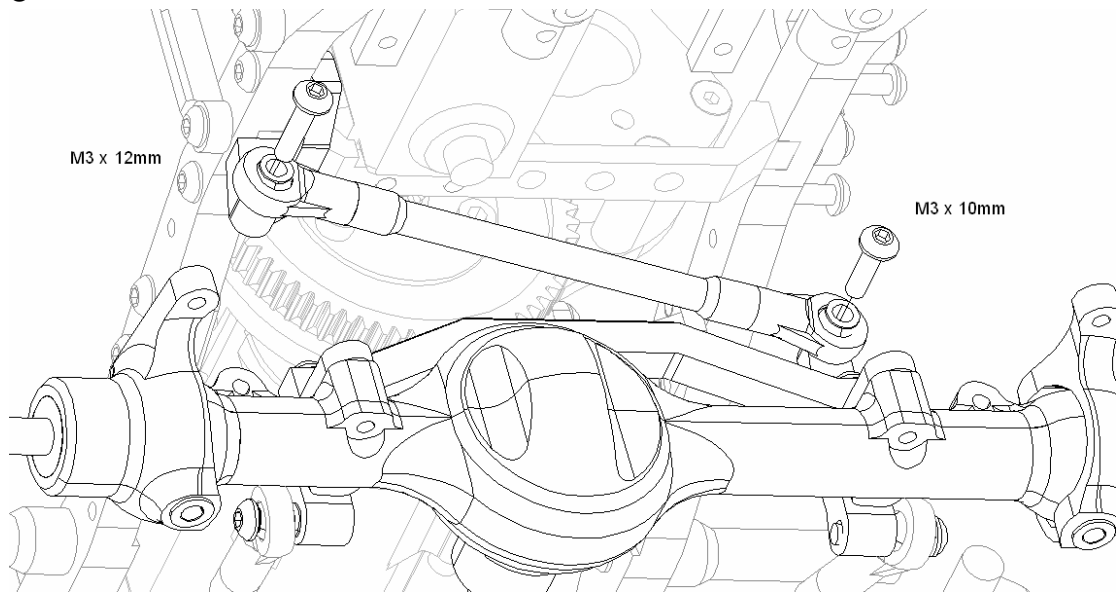

9

